



Mini-Split Air Conditioner OWNER 'S MANUAL

**14 SEER Dual-Zone Mini Split
Air Conditioner with Heat Pump.**



**KFMHP-18-ID/KFMHP-18-OD
KFMHP-24-ID/KFMHP-24-OD**

Thank you for selecting Soleus Air superior quality and high performance mini split air conditioner. To insure highest performance of operation please read this manual and have a qualified HVAC technician install according to the manual



Before using your air-conditioner , please read this operating instruction carefully and keep it for future reference .

CONTENT

| | |
|--------------------------------|----|
| FEATURES AND FUNCTIONS | 1 |
| PRECAUTIONS | 3 |
| NAME OF EACH PART | 5 |
| USE OF REMOTE CONTROLLER | 6 |
| CARE AND MAINTENANCE | 22 |
| TROUBLESHOOTING | 23 |
| EXCEPTION FOR MULTI SPLIT TYPE | 25 |

FEATURES AND FUNCTIONS

● INVERTER

At the start of operation, a large power is used to bring the room quickly to the desired temperature. Afterwards, the unit automatically switches to a low power setting for economic and comfortable operation.

● AIR DIRECTION POSITIONING

Automatic swing of Horizontal air flow in horizontal direction. The flap moves by hand in right and left direction to spread the conditioned air evenly throughout the room.

● WIRELESS REMOTE CONTROL UNIT

The Wireless Remote Control Unit allows convenient control of air conditioner operation.

● OPERATING TEMPERATURE RANGE

| | | Indoor | | Outdoor | |
|---------|-------------|-------------|-------------|-------------|-------------|
| | | DB[°C]/[°F] | WB[°C]/[°F] | DB[°C]/[°F] | WB[°C]/[°F] |
| Cooling | Upper Limit | 32/[90] | 23/[73] | 43/[109] | NA |
| | Lower Limit | 21/[70] | 15/[59] | 10/[50] | NA |
| Heating | Upper Limit | 27/[81] | NA | 24/[75] | 18/[64] |
| | Lower Limit | 10/[50] | NA | -15/[5] | -16/[3] |

● VERTICAL AIR SWING

Automatic swing of supply air in vertical direction. The flap moves automatically in upward and downward direction to spread the conditioned air evenly throughout the room.

● AUTO CHANGE OVER

The operation mode (cooling, dry, heating) is switched automatically to maintain the set temperature, and the set temperature is kept constant at all times.

This appliance is not intended for use by persons (including children) with reduced physical, sensory or mental capabilities , or lack of experience and knowledge, unless they have been given supervision or instruction concerning use of the appliance by a person responsible for their safety.

Children should be supervised to ensure that they do not play with the appliance.

PRECAUTIONS

Danger

This sign warns of death or serious injury.

- 1) Do not attempt to install this air conditioner by yourself.
- 2) This unit contains no user-serviceable parts . Always consult authorized service personnel for repairs.
- 3) When moving, consult authorized service personnel for disconnection and installation of the unit.
- 4) Do not become excessively chilled by staying for lengthy periods in the direct cooling airflow.
- 5) Do not insert fingers or objects into the outlet port or intake grilles.
- 6) Do not start and stop air conditioner operation by disconnecting the power supply cord and so on.
- 7) Take care not to damage the power supply cord.
- 8) The appliance is fitted with means for disconnection from the supply mains having a contact separation in all poles that provide full disconnection under over voltage category III conditions, and these means must be incorporated in the fixed wiring in accordance with the wiring rules.

Caution

This sign warns of damage to property.

- 1) Provide occasional ventilation during use .
- 2) Do not direct air flow at fireplaces or heating apparatus .
- 3) Do not climb on, or place objects on the air conditioner.
- 4) Do not hang objects from the indoor unit .
- 5) Do not set flower vases or water containers on top of air conditioners.
- 6) Do not expose the air conditioner directly to water.
- 7) Do not pull power supply cord.

- 8) Turn off power source when not using the unit for extended periods.
- 9) Check the condition of the installation stand for damage.
- 10) Do not place animals or plants in the direct path of the air flow.
- 11) Do not drink the water drained from the air conditioner.
- 12) Do not use in applications involving the storage of foods , plants or animals, precision equipment, or art works.
- 13) Connection valves become hot during Heating; handle with care.
- 14) Do not apply any heavy pressure to radiator fins.
- 15) Operate only with air filters installed.
- 16) Do not block or cover the intake grille and outlet port.
- 17) Ensure that any electronic equipment is at least one metre away from either the indoor or outdoor units.
- 18) Avoid installing the air conditioner near a fireplace or other heating apparatus.
- 19) When installing the indoor and outdoor unit , take precautions to prevent access to infants.
- 20) Do not use inflammable gases near the air conditioner .

NAME OF EACH PART

Features and appearance will vary. All the figures give a demonstration to introduce the function.

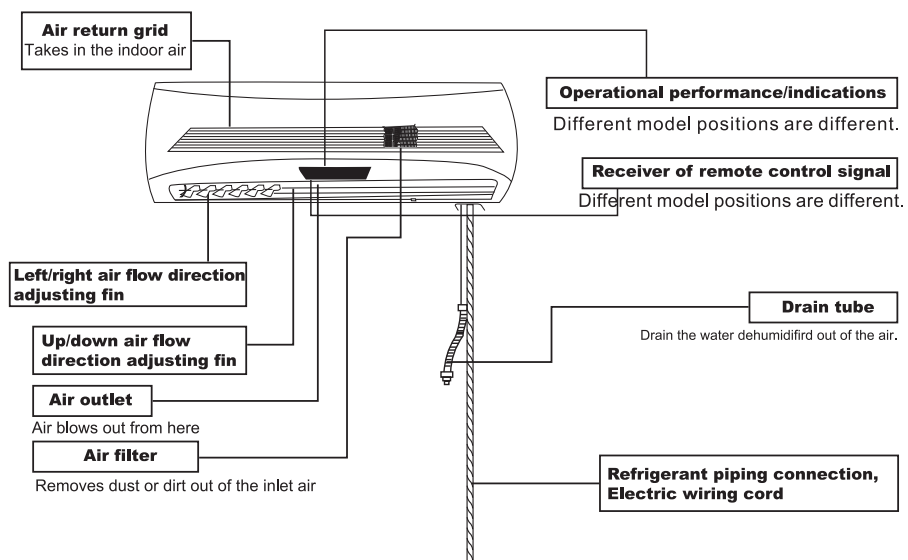

USE OF REMOTE CONTROLLER

Remote Control 1

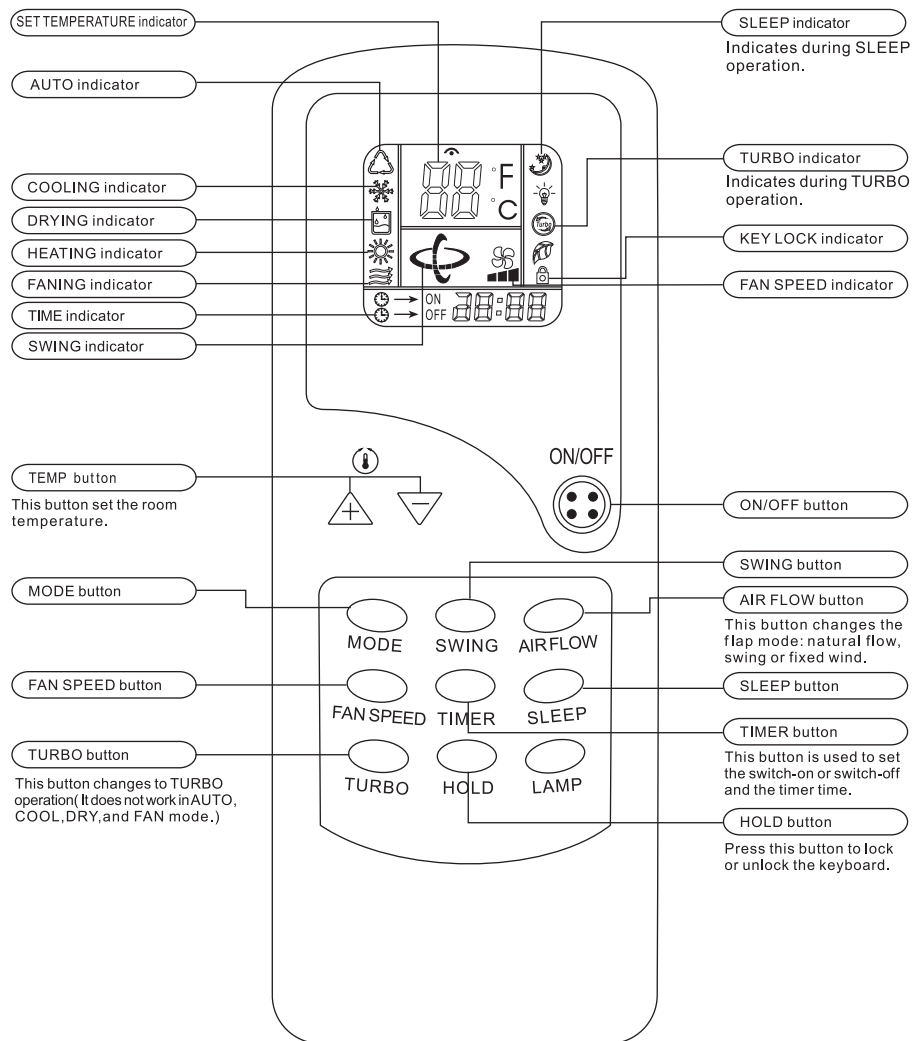

Remote Control 2

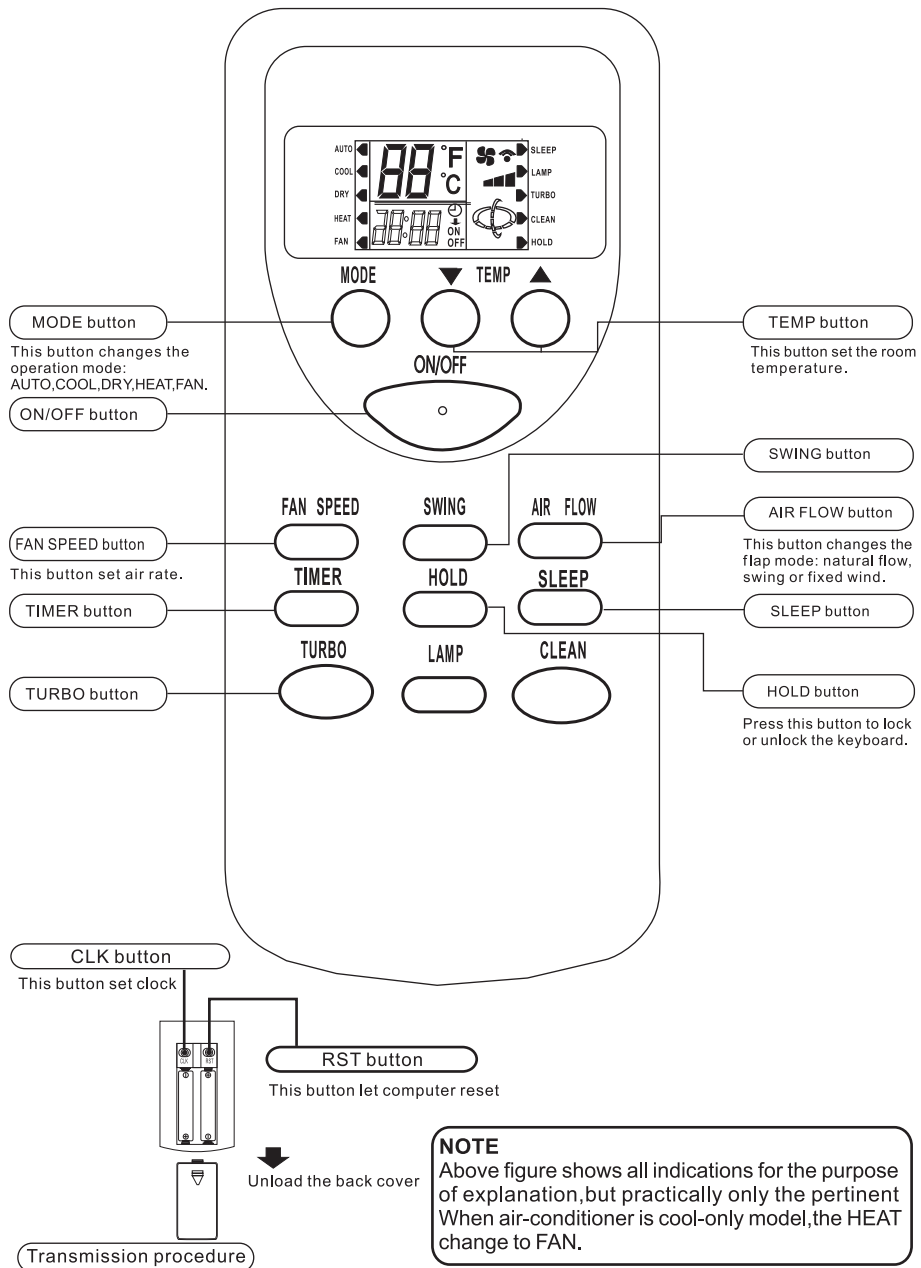

● OPERATING MACHINE IN SELECTED MODES

1. Point the remote controller at the unit , press the ON/ OFF button, then MODE button,select the needed mode:ATUO,COOL,DRY,HEAT or FAN.

2. Press the TEMP button to increase or decrease the redings until the needed temperature is displayed . The room set temperature range is from 16°C~32°C/61°F ~90°F.

(It would be automatically set at 25°C/77°F and unadjustable in AUTO and DRY mode.)

3. Press the FAN SPEED button to choose the air rate you want:

Low (display indicates "■"),Med(display indicates " ■■") ,Hi(display indicates "■■■") , Auto(display "■■■" indicator flashing).

(It would be automatically set at low speed and unadjustable in DRY mode.)

4. Press the SWING button to choose the up/down air flow direction you want: natural flow(display indicates " { "), swing(display " { " indicator flashing),fixed wind(display indicates " ⤴ ").

(It would be automatically set at fixed wind air flow direction in DRY mode .)

● TURBO OPERATION

Press " TURBO " button during " HEAT " operation, the air rate can be setted in " HIGH " . Press the TURBO button again can release the TURBO operation.

Note: during TURBO operation,the air rate cann' t be changed.

● ADJUSTING LEFT/RIGHT AIR FLOW DIRECTION

Adjust the direction by moving directly the left/right air flow direction adjusting fin by hand.

Caution: when adjust the direction,stop air conditioner.

● **TIMER OPERATION**

Set turning off time

Set the time for the unit to turn off and when it is time , the AC will automatically stop operating.

1. During the operation of the air conditioner , press the TIMER button and the air conditioner will enter the timed switch-off mode.
2. Gently press the TIMER button to set the needed time for switching off the machine .The timer can make the setting in the range from 1-24 hours. Every the button is pressed,indication change is the following sequence:1→ 2→ → 24→ cancel(no indication)→ 1.
3. After the setting of the timed switch-off , the digits shown on the display screen will go down by 1 for every elapsed .

Set turning on time

Set the time for the unit to turn on and when it is time, the AC will automatically start operating.

1. When the air conditioner is in the standby mode, press the TIMER button and the air conditioner will enter the timed switch-on mode.
2. Gently press the TIMER button to set the needed time for switching on the machine .The timer can make the setting in the range from 1-24 hours.Every the button is pressed,indication change is the following sequence:1→ 2→ → 24→ cancel(no indication)→ 1.
3. After the setting of the timed switch-on , the digits shown on the display screen will go down by 1 for every elapsed hour.The displayed digits indicate the remaining time prior to the timed switch-on.

Releasing procedure

When the indication on display screen is 24 hour, press the TIMER button again to delete the timed mode.

● SLEEP OPERATION

Use this mode to reduce operation sound when sleeping, etc .

Press the SLEEP button, the air flow sound from the indoor unit is decreased.

Press the SLEEP button again can release the mode.

NOTE:

1. Use the sleep mode when are going to bed. If this mode is used in the day , the capacity is reduced since the ambient temperature is too high.(COOL MODE).
2. During the operation of cooling,the room temperature will be raised gradually by 2°C / 4°F higher than the setting after the machine begins to operate in the sleeping mode.
3. During the operation of heating mode , the room temperature will be dropped gradually 5°C / 9°F lower than the setting after the machine begins to operate in the sleeping mode.

● REPLACEMENT OF BATTERIES

1. When the signal from the remote controller becomes weak and the indoor unit can not receive it properly; or the indications on the display screen becomes blurred,please slide the back cover and replace with two new batteries.
2. The positive and negative poles must match the installation positions.
3. New batteries of the same type have to be used for replacement.
4. If the remote controller is not to be used for long time,take out the batteries so as to prevent the leakage of the electrolyte from damaging the controller.

● DEFROSTING

When the outdoor air temperature is very low and humidity is very high,frosting will occur to the heat exchanger of the outdoor unit,

which has negative impacts up on the efficiency of the heating performance. In such case ,the automatic defrosting function will come into play . The heating operation will be stopped for 5-10 minutes to do the defrosting.

1. The fans of both the outdoor and indoor units are stopped.
2. During the defrosting, the outdoor unit might generate some steam. It is caused by fast defrosting,which is not a performance failure.
3. Upon the completion of the defrosting process , the heating operation is resumed.

Remote Control 3

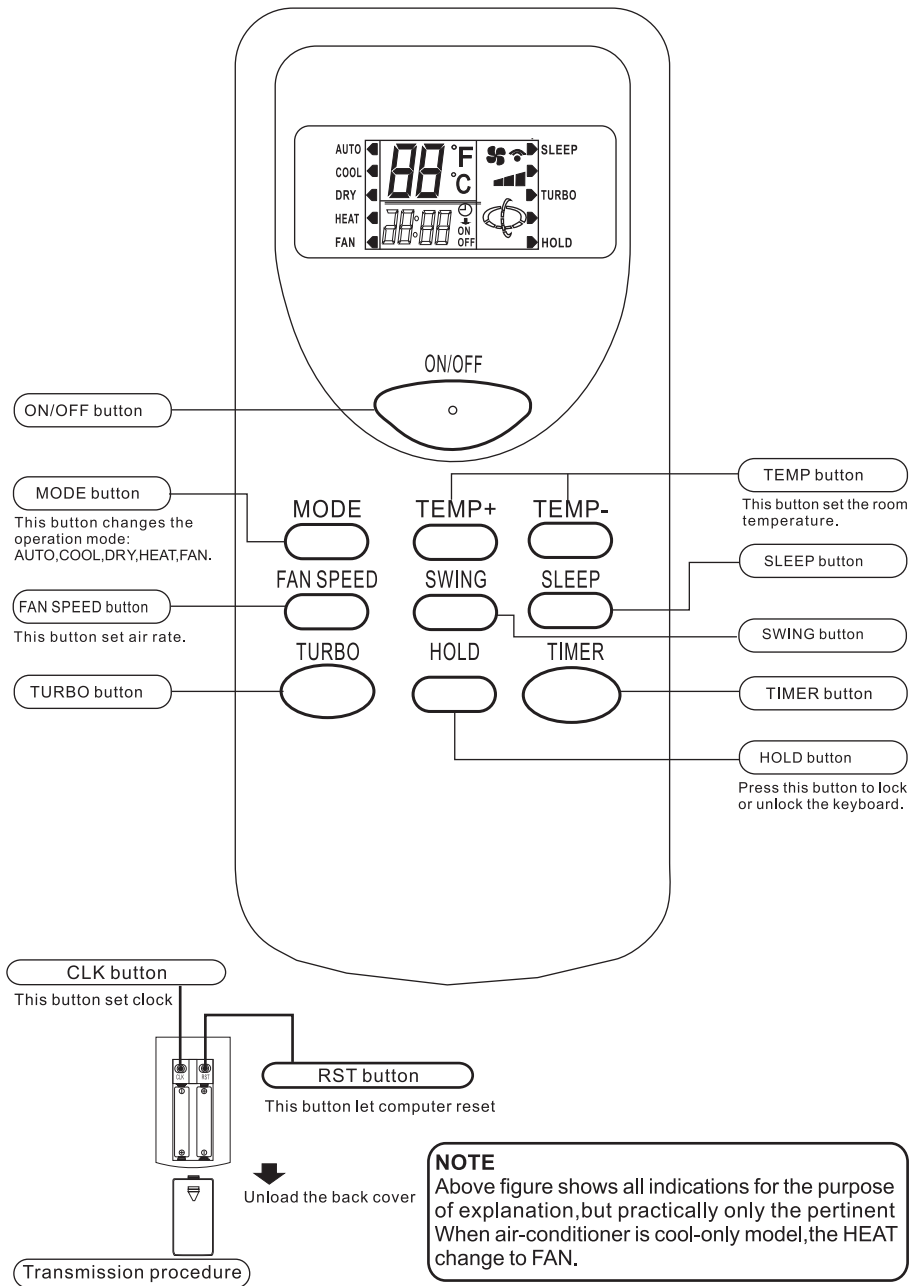

● OPERATING MACHINE IN SELECTED MODES

1. Point the remote controller at the unit , press the ON/ OFF button, then MODE button,select the needed mode:ATUO,COOL,DRY,HEAT or FAN.

2. Press the TEMP button to increase or decrease the redings until the needed temperature is displayed . The room set temperature range is from 16°C~32°C/61°F ~90°F.

(It would be automatically set at 25°C/77°F and unadjustable in AUTO and DRY mode.)

3. Press the FAN SPEED button to choose the air rate you want:

Low (display indicates "■"),Med(display indicates " ■■ ") ,Hi(display indicates " ■■■ ") , Auto(display " ■■■ " indicator flashing).

(It would be automatically set at low speed and unadjustable in DRY mode.)

4. Press the SWING button to choose the up/down air flow direction you want: natural flow(display indicates " ("), swing(display " (" indicator flashing),fixed wind(display indicates " ⌋ ").

(It would be automatically set at fixed wind air flow direction in DRY mode .)

● TURBO OPERATION

Press " TURBO " button during " HEAT " operation, the air rate can be setted in " HIGH " . Press the TURBO button again can release the TURBO operation.

Note: during TURBO operation,the air rate cann' t be changed.

● TIMER OPERATION

Set turning off time

Set the time for the unit to turn off and when it is time , the AC will automatically stop operating.

1. During the operation of the air conditioner, press the TIMER button

and the air conditioner will enter the timed switch-off mode.

2. Gently press the TIMER button to set the needed time for switching off the machine .The timer can make the setting in the range from 1-24 hours. Every the button is pressed,indication change is the following sequence:1→ 2→ → 24→ cancel(no indication)→ 1.

3. After the setting of the timed switch-off , the digits shown on the display screen will go down by 1 for every elapsed .

Set turning on time

Set the time for the unit to turn on and when it is time, the AC will automatically start operating.

1. When the air conditioner is in the standby mode,press the TIMER button and the air conditioner will enter the timed switch-on mode.

2. Gently press the TIMER button to set the needed time for switching on the machine.The timer can make the setting in the range from 1-24 hours.Every the button is pressed,indication change is the following sequence:1→ 2→ → 24→ cancel(no indication)→ 1.

3. After the set ting of the timed switch-on, the digits shown on the display screen will go down by 1 for every elapsed hour.The displayed digits indicate the remaining time prior to the timed switch-on.

Releasing procedure

When the indication on display screen is 24 hour,press the TIMER button again to delete the timed mode.

● SLEEP OPERATION

Use this mode to reduce operation sound when sleeping, etc .

Press the SLEEP button, the air flow sound from the indoor unit is decreased.

Press the SLEEP button again can release the mode.

NOTE:

1. Use the sleep mode when are going to bed. If this mode is used in the day , the capacity is reduced since the ambient temperature is too high.(COOL MODE).
2. During the operation of cooling,the room temperature will be raised gradually by 2°C/4°F higher than the setting after the machine begins to operate in the sleeping mode.
3. During the operation of heating mode , the room temperature will be dropped gradually 5°C/9°F lower than the setting after the machine begins to operate in the sleeping mode.

● REPLACEMENT OF BATTERIES



1. When the signal from the remote controller becomes weak and the indoor unit can not receive it properly; or the indications on the display screen becomes blurred, please slide the back cover and replace with two new batteries.
2. The positive and negative poles must match the installation positions.
3. New batteries of the same type have to be used for replacement.
4. If the remote controller is not to be used for long time,take out the batteries so as to prevent the leakage of the electrolyte from damaging the controller.

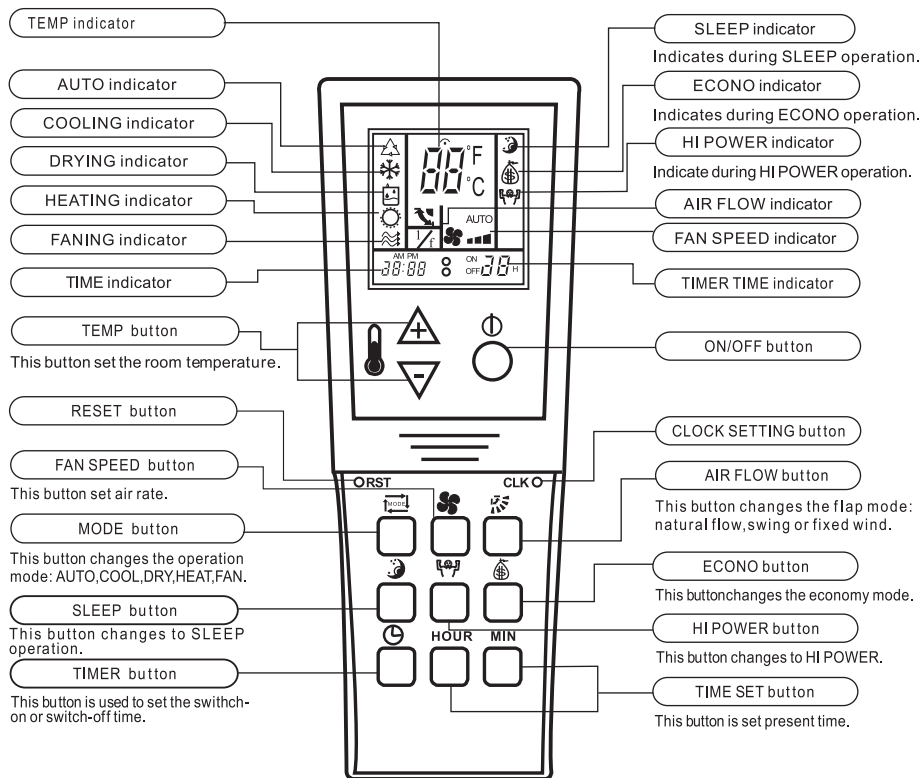

Remote Control 4



● OPERATING MACHINE IN SELECTED MODES

1. Point the remote controller at the unit, press the ON/OFF button, then press the " MODE " button, select the needed mode: AUTO, COOL, DRY, HEAT, or FAN.
2. Press the TEMP button to increase or decrease the readings until the needed temperature is displayed. The room set temperature range is from 16°C-32°C/61°F ~90°F.

3. Press the FAN SPEED button to choose the air rate you want: Low (display indicates "  "), Mid (display indicates "  "), Hi (display indicates "  "), Auto (display indicates " AUTO ").

4. Press the SWING button to choose the up/down air flow direction you want: natural flow (display indicates "  "), swing (display indicates "  "), fixed wind (no indications).

● ADJUSTING LEFT/RIGHT AIR FLOW DIRECTION

Adjust the direction by moving directly the left/right air flow direction adjusting fin by hand.

Caution: when adjust the direction, stop air conditioner.

● HIGH POWER OPERATION

Press HI POWER button during operation, the air rate can be set in " HIGH " and continues to operate 20 minutes.

Press the HI POWER button again can release the HI POWER operation .

● ECONOMY OPERATION

Press ECONO button during " COOL " operation, the setted-temperature can raise 2°C/36°F, and the air rate can be set in " LOW " . Press the ECONO button again can release the ECONO operation.

NOTE: On DRY mode, the unit will automatically run as following operation state: 25°C/ 77°F set temperature, fixed wind air flow , low speed air rate. HI POWER and ECONO operations do not work on this mode.

● PRESENT TIME SETTING PROCEDURE

1. When cells air inserted, push the CLK button with the tip of a ball pen, etc. The time indicator is flickering and can set the present time.

2. Press the HOUR button to set you desired time.

3. Press the MIN button to set you desired time.

4. Press the CLK button again and the present time is confirmed.

If when the remote controller is at abnormal state, you can press the

RST button to clear off the display.

- **TIMER OPERATION**

- Set turning off time**

- Set the time for the unit to turn off and when it is time, the air conditioner will automatically stop operating.

- 1. During the operation of the air conditioner, press the TIMER button and the air conditioner will enter the timed switch-off mode.
 2. Gently press the TIMER button to set the needed time for switching off the machine. The timer can make the setting in the range from 1-24 hours. Every the button is pressed, indication change is the following sequence: 1 → 2 → → 24 → cancel (no indication) → 1.
 3. After the setting of the timed switch-off, the digits shown on the display screen will go down by 1 for every elapsed hour. The displayed digits indicate the remaining time prior to the timed switch-off.

- Set turning time**

- Set the time for the unit to turn on and when it is time, the air conditioner will automatically start operating.

- 1. When the air conditioner is in the standby mode, press the TIMER button and the air conditioner will enter the timed switch-on mode.
 2. Gently press the TIMER button to set the needed time for switching on the machine. The timer can make the setting in the range from 1-24 hours. Every the button is pressed, indication change is the following sequence: 1 → 2 → → 24 → cancel (no indication) → 1.
 3. After the setting of the timed switch-on, the digits shown on the display screen will go down by 1 for every elapsed hour. The displayed digits indicate the remaining time prior to the timed switch-on.

- Releasing procedure**

- When the indication on display screen is 24 hour, press the TIMER button again to delete the timed mode.

● SLEEP OPERATION

Use this mode to reduce operation sound when sleeping, etc.

Press the SLEEP button , the air flow sound from the indoor unit is decreased and the light of display screen will be closed . Press the SLEEP button again can release the mode.

NOTE:

1. Use the sleep mode when you are going to bed. If this mode is used in the day, the capacity is reduced since the ambient temperature is too high. (COOL MODE).
2. During the operation of cooling, the room temperature will be raised gradually by 2°C/36°F higher than the setting after the machine begins to operate in the sleeping mode.
3. During the operation of heating mode, the room temperature will be dropped gradually 5°C/41°F lower than the setting after the machine begins to operate in the sleeping mode.

● FEATURES OF HEATING OPERATIONS

Basic principles and performances

1. The machines absorb heat from the outdoor air and transfer it indoors so as to heat the room air . The heating capabilities through this principle of heat pump go up/down with the increase/decrease of the temperatures of the outdoor air.
2. It only needs a fairly short time for such hot air circulation system to raise the room temperature.
3. When the outdoor air temperature is very low, the system can be used together with other heating devices , But good ventilation should be maintained to ensure safety and prevent accidents.

Defrosting

When the outdoor air temperature is very low and humidity is very

high, frosting will occur to the heat exchanger of the outdoor unit, which has negative impacts upon the efficiency of the heating performance. In such case, the automatic defrosting function will come into play. The heating operation will be stopped for 16.4-32.8FT to do the defrosting.

1. The fans of both the outdoor and indoor units are stopped.
2. During the defrosting, the outdoor unit might generate some steam, It is caused by fast defrosting, which is not a performance failure.
3. Upon the completion of the defrosting process, the heating operation is resumed.

● **OPERATION TIPS**

1. Set a suitable room temperature; excessively low room temperature is not good for your health and wastes electricity. Avoid frequent setting of the temperature.
2. During cooling, avoid direct sun. Keep curtains and blinds closed, Close doors and windows to keep the cool air in the room.
3. Avoid generating heat or using of heating appliances while the air conditioner in cooling mode.
4. Make sure that the air flap is positioned properly : horizontal flow in cooling and downward vertical flow for heating.
5. Keep the room temperature uniform by adjusting the left/right vertical air blades.
6. Position the air flap and the left/right air blades in such a manner as to prevent your body from being exposed directly to air drafts.
7. During prolonged operation, ventilate the room occasionally by opening a window from time to time.
8. In a power failure, the microprocessor memory is retained. When restarted, operation will be resumed in the last mode of operation. However, if the timer was used, the unit will be turned off by the timer

only if the remote control is aimed at the unit. Otherwise the power failure will cause the timer data to be erased from the microprocessor memory.

9. After turning on, allow more than 3 minutes for cooling, heating or dry operation to start.

10. When DRY mode is used, make sure that the room temperature is between 20°C/68°F and 27°C/81°F. When used out of this range, the unit may protect itself and become inoperative.

11. When COOL or DRY modes are used, make sure that the room's relative humidity is below 78%. If the unit is used for a prolonged period of time in high humidity, moisture may form on the air outlet and drip down.

12. Remote control signals may not be received if the indoor unit controls cover is exposed to direct sunlight or strong light. In such a case, block the sunlight or dim the lighting.

13. The remote control is operative in a range of 8 meters (26 FT). If you are out of range, the remote control may have difficulties in transmitting signals.

CARE AND MAINTENANCE

Before performing any maintenance procedure, make sure to disconnect the air conditioner from the power.

● CLEANING THE AIR FILTER

1. Your air conditioner is provided with a filter cleaning indicator. When the indicator (F) lights up, the filters should be removed for cleaning.
2. To remove the air filters, lift up the panel, push the air filters up slightly to unlock them. pull out the filters, Clean the filter by washing in warm soapy water and dry thoroughly , align and fit the filters in place, close the panel by pushing it in the center to lock it in place.
3. Reset button (I) to turn off indicator(F).

DO NOT OPERATE THE UNIT WITHOUT FILTERS !

● CLEANING THE AIR CONDITIONER

1. Wipe the unit with a soft dry cloth or clean it using a vacuum cleaner .
2. Do not use hot water or volatile materials which could damage the surface of the air conditioner.

● AT THE BEGINNING OF THE SEASON

1. Make sure there are no obstacles blocking the flow of inlet or outlet air, in both indoor and outdoor units.
2. Make sure the power is properly connected.

● PROTECT THE ELECTRONIC SYSTEM

1. Indoor unit and remote control must be at least 1 meter away from a TV, radio or any other home electronic appliance.
2. Protect the inner unit from direct sun or lighting.

TROUBLESHOOTING

Before calling for service , please check the following common malfunctions and correct it as needed .

| Problem | Cause | Remedy |
|--|---|---|
| ● Unit does not operate. Stand-by indicator lights. | ◇ Remote control malfunctions ◇ The remote control is locked | ◆ Check remote control batteries ◆ Try to operate from a closer distance ◆ Start from on-unit controls ◆ Unlock the remote control |
| ● Unit does not respond properly to remote control command | ◇ IR signal does not reach unit ◇ Distance between remote control and unit too large or aimed at from improper angle ◇ IR receiver on-unit exposed to strong light source | ◆ Check for obstruction between unit and remote control. Clear if needed. ◆ Get closer to unit. ◆ Dim lights, fluorescents especially |
| ● Air does not blow out from indoor unit | ◇ De-icing protection mode is activated ◇ Unit in AUTO FAN mode ◇ Over cooling in DRY | ◆ Normal operation in HEATING mode ◆ Normal operation in DRY mode |
| ● COOLING , DRY or HEATING does not start immediately | ◇ 3-min. Compressor delayed start | ◆ Normal operation for these modes |
| ● Unit functions but does not perform sufficiently | ◇ Improper temperature setting ◇ Unit capacity insufficient for load or room size | ◆ Reset temperature ◆ Consult your dealer |

● **Self Diagnosis Functions**

Our company has provided the thoughtful services for customers , and the air conditioner had been installed self diagnosis system to display the code for failure.

(1) Indoor unit fault shows as following:

| Failure | Failure code |
|---|---------------------|
| Communication failure | F1 |
| Failure of room temperature sensor. | F2 |
| Failure of tube-exit temperature sensor | F3 |
| Failure of tube-entry temperature sensor | F3 |
| Failure of tube-midpoint temperature sensor | F3 |
| Failure of PG fan | F4 |

(2) Outdoor unit fault shows as following:

| Fault | Fault code |
|--|-------------------|
| Fault of outdoor unit transducer module protecting. | P2 |
| Outdoor unit AC input too big. | P3 |
| Outdoor unit compressor exhaust temperature too high, outdoor environment temperature ultra warm , compressor outer cover temperature switch disconnection . | P4 |
| The outdoor machine direct current bus bar is unusual in voltage. | P7 |
| Fault of lack refrigerant or fault of reversing valve. | P8 |
| Fault of the outdoor temperature sensor. | F6 |
| Fault of outdoor unit drive, fault of compressor start. | FC |

EXCEPTION FOR MULTI SPLIT TYPE

The same outdoor unit, it may happen that the requested operation mode can not be operated.

The reason for that is that the system is currently operating in a different mode.

The system operation mode can be either cooling or heating and is set by the outdoor unit controls, based on indoor and outdoor unit settings.

The rules for the mode settings may be different from one application to another.

In most applications the system operation mode will not be changed as long as there is an operating indoor unit requesting the active mode. The operation mode in such application will be set by the first indoor unit that is turned ON from Stand By.

The following table shows the indoor unit operation modes that can be operated per active system mode :

| | | System Active Mode | |
|--------------------------------------|----------------|--------------------|-----------------|
| | | Cooling | Heating |
| Requested indoor unit operation mode | Ventilation | √ | × |
| | Cooling | × | √ |
| | Heating | √ | × |
| | Dry | √(cooling only) | √(heating only) |
| | Auto Cool/Heat | √ | × |

(√-enabled indoor unit operation mode, ×-disabled indoor unit operation mode)

Indoor unit operation when the requested mode is disabled is as following:

1. Louver opens;
2. Green(OPER)LED blinks once in two seconds;
3. Indoor fan is forced off.

| Model | | KFMHP-18-ID KFMHP-18-OD | KFMHP-24-ID KFMHP-24-OD |
|------------------------|------------------------------------|----------------------------|----------------------------|
| Power Supply (Ph-V-Hz) | | 1/230/60 | 1/230/60 |
| Breaker Size (A) | | 20 | 20 |
| Cooling | Rated Capacity (BTU) | 18,000 | 23,000 |
| | Capacity Inverter Range(Wattage) | 5,000(2,000-6,800) | 6.400(3,000-8,500) |
| | Input/Actual Input(Wattage) | 1385/1450 | 1830/1882 |
| | Max.Power (Wattage) | 2450 | 3000 |
| | Max.Current(Amperage) | 11 | 13 |
| | Declared EER/Actual EER | 12.3/11.8 | 11.9/11.6 |
| | SEER | 15.6 | 14.2 |
| Heating | Rated Capacity (BTU) | 21,000 | 26,000 |
| | HSPF | 7.7 | 7.7 |
| | Capacity Inverter Range(Wattage) | 2,800-7,000 | 2,800-8,000 |
| | Max.Power (Wattage) | 2,580 | 3,200 |
| | Max.Current(Amperage) | 11.5 | 13.5 |
| | Input/Actual Input(Wattage) | 1,550/1,580 | 2,000/2,060 |
| | Declared COP/Actual COP (w/w.h) | 3.75/3.65 | 3.5/3.4 |
| Indoor | CFM (H/M/L) | 324/306/194 | 441/406/217 |
| | Noise Level dB (A) | 41 | 43 |
| | Indoor Unit Tubing Diameters(Inch) | ∅ 0.28x0.25 | ∅ 0.28x0.25 |
| | Indoor Unit Core | 16.46-3F | 16.46-3F |
| | Indoor Unit Dimension (W*D*H) | 34.3"X7.1"X10.6" | 40.2"X13.8"X10.8" |
| | Indoor Packing Dimension (W*D*H) | 35"X8.1"X11.3" | 41"X14.5"X11.3" |
| | Indoor Net/Gross Weight (Lb) | 26/31 | 31/35 |
| | Design Pressure(PSIG) | 510 | 510 |
| outdoor | Outdoor Unit Dimension (W*D*H) | 39"X16.1"X30.7" | 41.7"X18.5"X36.4" |
| | Outdoor Packing Dimension (W*D*H) | 40"X17"X31.2" | 42.4"X19"X37" |
| | Outdoor Net/Gross Weight (Lb) | 128/143 | 163/181 |
| | Design Pressure(PSIG) | 510 | 510 |
| | Noise Level dB (A) | 57 | 57 |
| | Outdoor Unit Core | S3P | NSP |
| Lines Sets | Line Set Size(Inch) | 1/4,3/8 | 1/4,1/2 |
| | Refrigerant Type (lbs) | R410A/3.9lbs | R410A/6.6lbs |
| | Max. Length [Ft] | 82 | 82 |
| | Max.Vertical Separate(Ft) | 32.8 | 32.8 |
| | Factory Charge(Ft) | 16.4 | 16.4 |
| | Add Charge(Lbs/Ft) | 0.01 | 0.01 |

Warranty

Soleus International Inc. warrants the accompanying Soleus Air 14 SEER Dual-Zone Mini Split Air Conditioner (Models: KFMHP-18-ID/KFMHP-18-OD and KFMHP-24-ID/KFMHP-24-OD) to be free of defects in material and workmanship for the applications specified in its operation instruction for the period of parts specified below.

| |
|-----------------------------|
| 5 YEARS FOR COMPRESSOR |
| 1 YEAR FOR OTHER COMPONENTS |

This warranty shall not apply to broken or marred cabinets, accessories, knobs, filters or routine maintenance. This warranty does not apply to uncrating, setup, installation, removal of the product for repair or reinstallation of the product after repair.

This warranty does not apply to repairs or replacements necessitated by any cause beyond the control of Soleus International including, but not limited to, any malfunction, defect or failure caused by or resulting from unauthorized service or parts, improper maintenance, operation contrary to furnished instructions, shipping or transit accidents, modification or repair by the user, abuse, misuse, neglect, accident, incorrect power line voltage, fire, flood or other Acts of God, or normal wear and tear.

Warranty service must be performed by a qualified HVAC contractor. Soleus maintains a centralized service network to provide parts and assist in resolving service problems if difficulties are encountered. Soleus agrees to provide service information, sell repair parts and reimburse the dealer /serviceman for parts in accordance with Soleus International's Policies and Procedures.

SOLEUS INTERNATIONAL MAINTAINS THAT ALL WARRANTIES, INCLUDING IMPLIED WARRANTY OR MERCHANTABILITY ARE LIMITED TO THE TERMS AND CONDITIONS SPECIFIED ABOVE. SOLEUS INTERNATIONAL DISCLAIMS ANY LIABILITY FOR CONSEQUENTIAL OR INCIDENTAL DAMAGES AND IN NO EVENT SHALL SOLEUS INTERNATIONAL INC.'S LIABILITY EXCEED THE RETAIL VALUE OF THE AIR CONDITIONER.

This warranty covers only new products purchased from our authorized dealers or retailers. It does not cover internet sales, used, salvaged, or refurbished products.

FOR TECHNICAL SUPPORT AND WARRANTY SERVICE

Soleus International Inc.
Tel: 1-888-8 SOLEUS
Monday through Friday, 9:00 AM to 5:00 PM, PST
Email: Contact@soleusair.com
Website: www.soleusair.com